

BUH100G

SWITCHMODE™ NPN Silicon Planar Power Transistor

The BUH100G has an application specific state-of-art die designed for use in 100 Watts Halogen electronic transformers.

This power transistor is specifically designed to sustain the large inrush current during either the startup conditions or under a short circuit across the load.

Features

- Improved Efficiency Due to the Low Base Drive Requirements:
High and Flat DC Current Gain h_{FE}
Fast Switching
- Robustness Thanks to the Technology Developed to Manufacture this Device
- ON Semiconductor Six Sigma Philosophy Provides Tight and Reproducible Parametric Distributions
- These Devices are Pb-Free and are RoHS Compliant*

MAXIMUM RATINGS

Rating	Symbol	Value	Unit
Collector-Emitter Sustaining Voltage	V_{CEO}	400	Vdc
Collector-Base Breakdown Voltage	V_{CBO}	700	Vdc
Collector-Emitter Breakdown Voltage	V_{CES}	700	Vdc
Emitter-Base Voltage	V_{EBO}	10	Vdc
Collector Current – Continuous – Peak (Note 1)	I_C I_{CM}	10 20	Adc
Base Current – Continuous – Peak (Note 1)	I_B I_{BM}	4 10	Adc
Total Device Dissipation @ $T_C = 25^\circ\text{C}$ Derate above 25°C	P_D	100 0.8	W W/ $^\circ\text{C}$
Operating and Storage Temperature	T_J, T_{stg}	-60 to 150	$^\circ\text{C}$

THERMAL CHARACTERISTICS

Characteristics	Symbol	Max	Unit
Thermal Resistance, Junction-to-Case	$R_{\theta JC}$	1.25	$^\circ\text{C}/\text{W}$
Thermal Resistance, Junction-to-Ambient	$R_{\theta JA}$	62.5	$^\circ\text{C}/\text{W}$
Maximum Lead Temperature for Soldering Purposes 1/8" from Case for 5 Seconds	T_L	260	$^\circ\text{C}$

Stresses exceeding Maximum Ratings may damage the device. Maximum Ratings are stress ratings only. Functional operation above the Recommended Operating Conditions is not implied. Extended exposure to stresses above the Recommended Operating Conditions may affect device reliability.

1. Pulse Test: Pulse Width = 5 ms, Duty Cycle $\leq 10\%$.

*For additional information on our Pb-Free strategy and soldering details, please download the ON Semiconductor Soldering and Mounting Techniques Reference Manual, SOLDERRM/D.



ON Semiconductor®

<http://onsemi.com>

POWER TRANSISTORS
10 AMPERES
700 VOLTS – 100 WATTS

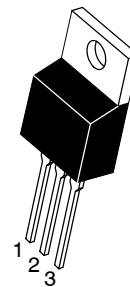
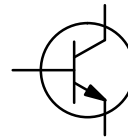

TO-220AB
CASE 221A-09
STYLE 1

MARKING DIAGRAM

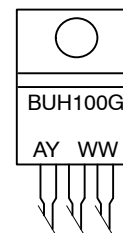

A = Assembly Location
Y = Year
WW = Work Week
G = Pb-Free Package

ORDERING INFORMATION

Device	Package	Shipping
BUH100G	TO-220AB (Pb-Free)	50 Units / Rail

BUH100G

ELECTRICAL CHARACTERISTICS ($T_C = 25^\circ\text{C}$ unless otherwise noted)

Characteristic	Symbol	Min	Typ	Max	Unit
OFF CHARACTERISTICS					
Collector-Emitter Sustaining Voltage ($I_C = 100\text{ mA}$, $L = 25\text{ mH}$)	$V_{CEO(sus)}$	400	460		Vdc
Collector-Base Breakdown Voltage ($I_{CBO} = 1\text{ mA}$)	V_{CBO}	700	860		Vdc
Emitter-Base Breakdown Voltage ($I_{EBO} = 1\text{ mA}$)	V_{EBO}	10	12.5		Vdc
Collector Cutoff Current ($V_{CE} = \text{Rated } V_{CEO}$, $I_B = 0$)	I_{CEO}			100	μAdc
Collector Cutoff Current ($V_{CE} = \text{Rated } V_{CES}$, $V_{EB} = 0$)	I_{CES}			100 1000	μAdc
Collector Base Current ($V_{CB} = \text{Rated } V_{CBO}$, $V_{EB} = 0$)	I_{CBO}			100 1000	μAdc
Emitter-Cutoff Current ($V_{EB} = 9\text{ Vdc}$, $I_C = 0$)	I_{EBO}			100	μAdc

ON CHARACTERISTICS

Base-Emitter Saturation Voltage ($I_C = 5\text{ Adc}$, $I_B = 1\text{ Adc}$)	@ $T_C = 25^\circ\text{C}$	$V_{BE(sat)}$		1	1.1	Vdc
Collector-Emitter Saturation Voltage ($I_C = 5\text{ Adc}$, $I_B = 1\text{ Adc}$) ($I_C = 7\text{ Adc}$, $I_B = 1.5\text{ Adc}$)	@ $T_C = 25^\circ\text{C}$ @ $T_C = 125^\circ\text{C}$	$V_{CE(sat)}$		0.37 0.37	0.6 0.6	Vdc
	@ $T_C = 25^\circ\text{C}$ @ $T_C = 125^\circ\text{C}$			0.5 0.6	0.75 1.5	Vdc
DC Current Gain ($I_C = 1\text{ Adc}$, $V_{CE} = 5\text{ Vdc}$) ($I_C = 5\text{ Adc}$, $V_{CE} = 5\text{ Vdc}$) ($I_C = 7\text{ Adc}$, $V_{CE} = 5\text{ Vdc}$) ($I_C = 10\text{ Adc}$, $V_{CE} = 5\text{ Vdc}$)	@ $T_C = 25^\circ\text{C}$ @ $T_C = 125^\circ\text{C}$	h_{FE}	15 16	24 28		
	@ $T_C = 25^\circ\text{C}$ @ $T_C = 125^\circ\text{C}$		10 10	15 14.5		
	@ $T_C = 25^\circ\text{C}$ @ $T_C = 125^\circ\text{C}$		8 7	12 10.5		
	@ $T_C = 25^\circ\text{C}$ @ $T_C = 125^\circ\text{C}$		6 4	9.5 8		

DYNAMIC SATURATION VOLTAGE

Dynamic Saturation Voltage: Determined 3 μs after rising I_{B1} reaches 90% of final I_{B1} (See Figure 19)	$I_C = 5\text{ Adc}$, $I_{B1} = 1\text{ Adc}$ $V_{CC} = 300\text{ V}$	@ $T_C = 25^\circ\text{C}$	$V_{CE(dsat)}$		1.1		V
		@ $T_C = 125^\circ\text{C}$			2.1		V
	$I_C = 7.5\text{ Adc}$, $I_{B1} = 1.5\text{ Adc}$ $V_{CC} = 300\text{ V}$	@ $T_C = 25^\circ\text{C}$			1.7		V
		@ $T_C = 125^\circ\text{C}$			5		V

DYNAMIC CHARACTERISTICS

Current Gain Bandwidth ($I_C = 1\text{ Adc}$, $V_{CE} = 10\text{ Vdc}$, $f = 1\text{ MHz}$)	f_T		23		MHz
Output Capacitance ($V_{CB} = 10\text{ Vdc}$, $I_E = 0$, $f = 1\text{ MHz}$)	C_{ob}		100	150	pF
Input Capacitance ($V_{EB} = 8\text{ Vdc}$, $f = 1\text{ MHz}$)	C_{ib}		1300	1750	pF

BUH100G

ELECTRICAL CHARACTERISTICS (T_C = 25°C unless otherwise noted)

Characteristic		Symbol	Min	Typ	Max	Unit
SWITCHING CHARACTERISTICS: Resistive Load (D.C. ≤ 10%, Pulse Width = 40 μs)						
Turn-on Time	I _C = 1 Adc, I _{B1} = 0.2 Adc I _{B2} = 0.2 Adc V _{CC} = 300 Vdc	@ T _C = 25°C	t _{on}	130	200	ns
Turn-off Time		@ T _C = 125°C	t _{off}	6.8 8.5	8	μs
Turn-on Time	I _C = 1 Adc, I _{B1} = 0.2 Adc I _{B2} = 0.4 Adc V _{CC} = 300 Vdc	@ T _C = 25°C	t _{on}	140	200	ns
Turn-off Time		@ T _C = 125°C	t _{off}	3.4 4.3	4	μs
Turn-on Time	I _C = 5 Adc, I _{B1} = 1 Adc I _{B2} = 1 Adc V _{CC} = 300 Vdc	@ T _C = 25°C	t _{on}	250	500	ns
Turn-off Time		@ T _C = 125°C	t _{off}	2.9 3.6	3.5	μs
Turn-on Time	I _C = 7.5 Adc, I _{B1} = 1.5 Adc I _{B2} = 1.5 Adc V _{CC} = 300 Vdc	@ T _C = 25°C	t _{on}	500	700	ns
Turn-off Time		@ T _C = 125°C	t _{off}	2.1 2.5	2.5	μs

SWITCHING CHARACTERISTICS: Inductive Load (V_{clamp} = 300 V, V_{CC} = 15 V, L = 200 μH)

Fall Time	I _C = 1 Adc I _{B1} = 0.2 Adc I _{B2} = 0.2 Adc	@ T _C = 25°C	t _{fi}	150	250	ns
Storage Time		@ T _C = 125°C	t _{si}	5.1 5.8	6	μs
Crossover Time		@ T _C = 25°C	t _c	230 300	325	ns
Fall Time	I _C = 1 Adc I _{B1} = 0.2 Adc I _{B2} = 0.5 Adc	@ T _C = 25°C	t _{fi}	150	250	ns
Storage Time		@ T _C = 125°C	t _{si}	2.5 2.8	3	μs
Crossover Time		@ T _C = 25°C	t _c	260 300	350	ns
Fall Time	I _C = 5 Adc I _{B1} = 1 Adc I _{B2} = 1 Adc	@ T _C = 25°C	t _{fi}	100	150	ns
Storage Time		@ T _C = 125°C	t _{si}	2.9 4.6	3.5	μs
Crossover Time		@ T _C = 25°C	t _c	220 450	300	ns
Fall Time	I _C = 7.5 Adc I _{B1} = 1.5 Adc I _{B2} = 1.5 Adc	@ T _C = 25°C	t _{fi}	100	150	ns
Storage Time		@ T _C = 125°C	t _{si}	2 2.5	2.5	μs
Crossover Time		@ T _C = 25°C	t _c	250 475	350	ns

TYPICAL STATIC CHARACTERISTICS

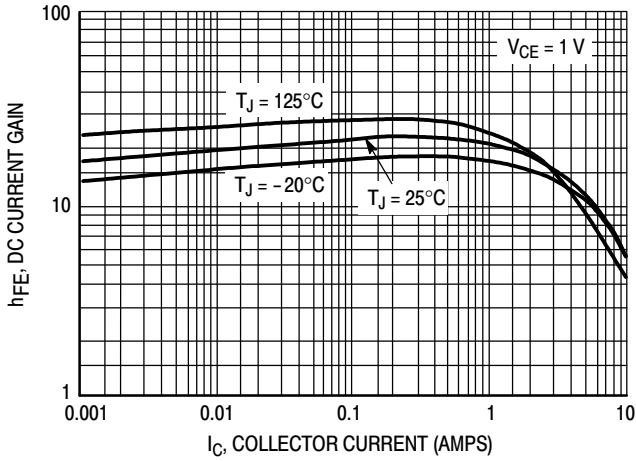

Figure 1. DC Current Gain @ 1 Volt

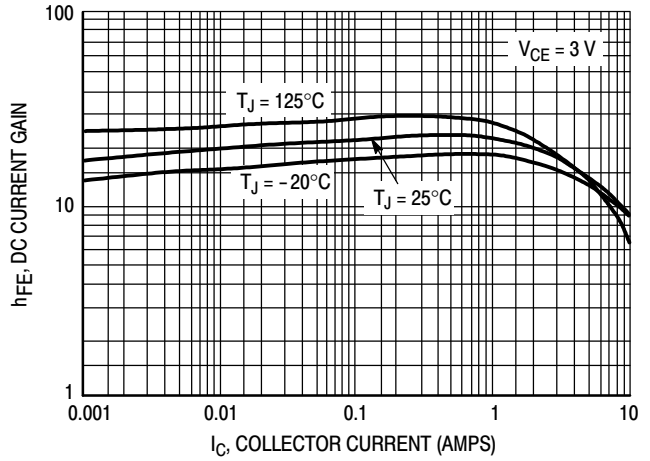

Figure 2. DC Current Gain @ 3 Volt

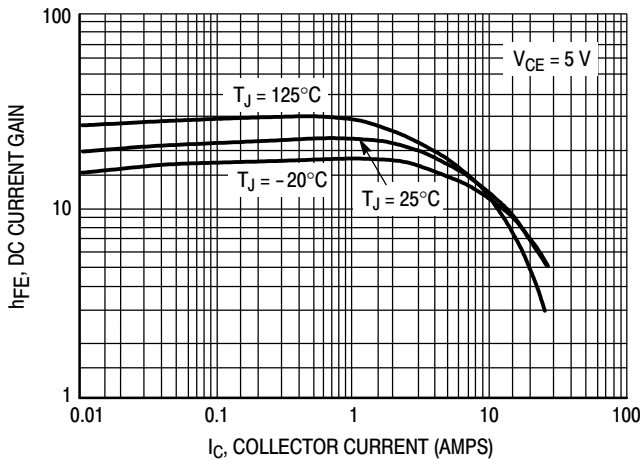

Figure 3. DC Current Gain @ 5 Volt

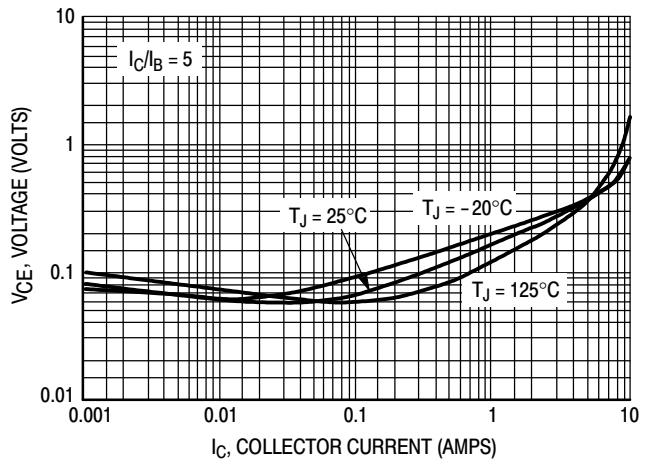

Figure 4. Collector-Emitter Saturation Voltage

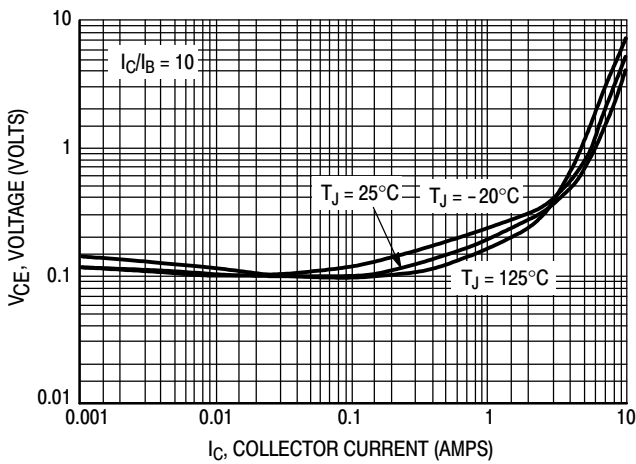

Figure 5. Collector-Emitter Saturation Voltage

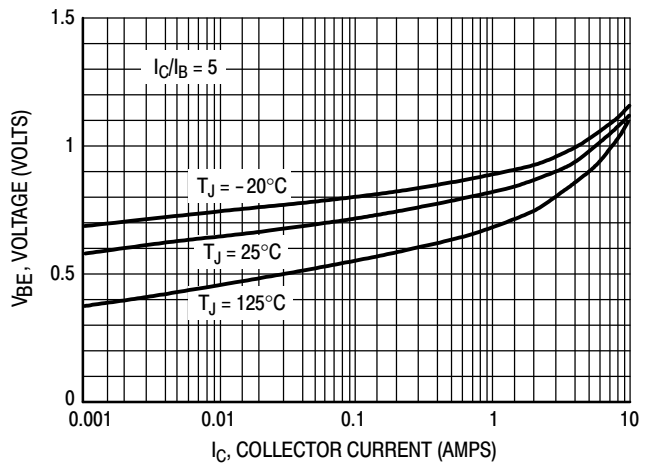

Figure 6. Base-Emitter Saturation Region

TYPICAL STATIC CHARACTERISTICS

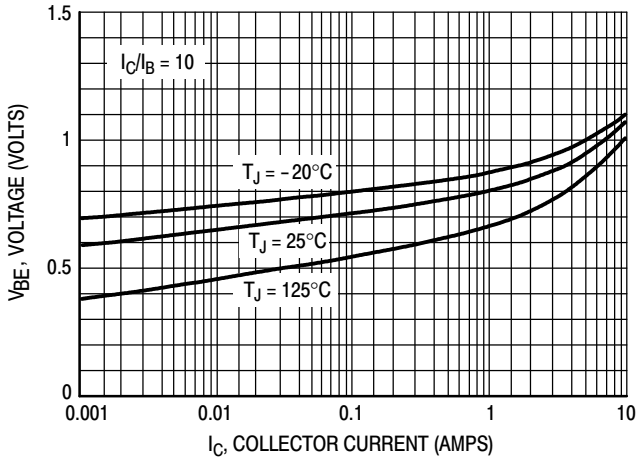

Figure 7. Base-Emitter Saturation Region

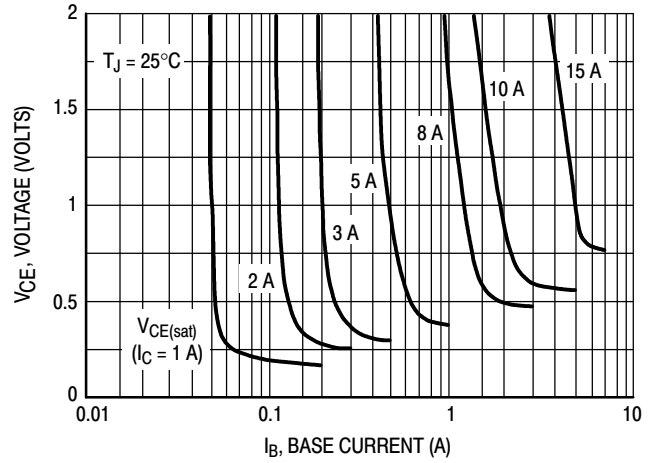

Figure 8. Collector Saturation Region

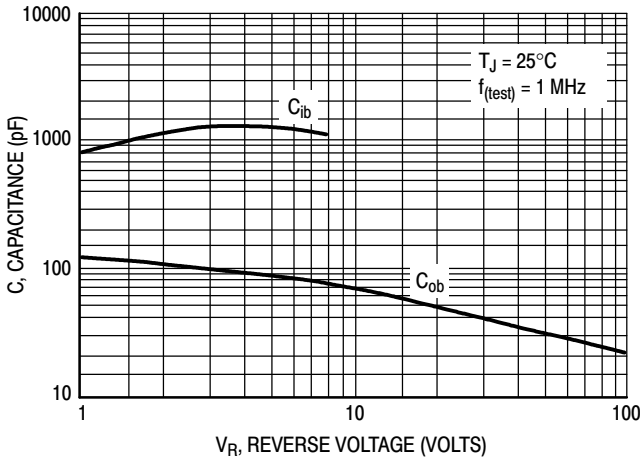

Figure 9. Capacitance

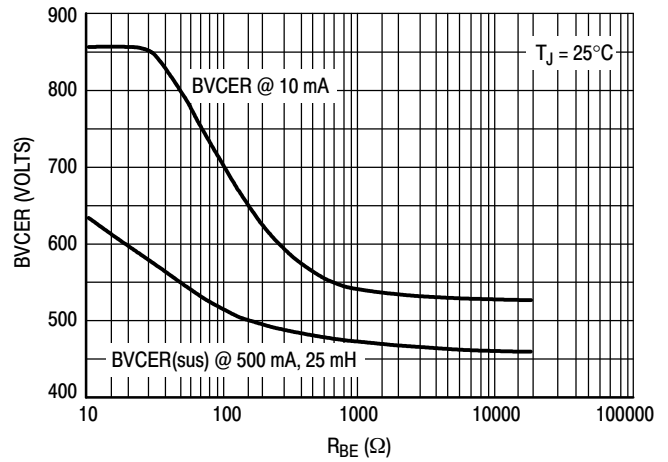

Figure 10. Resistive Breakdown

TYPICAL SWITCHING CHARACTERISTICS

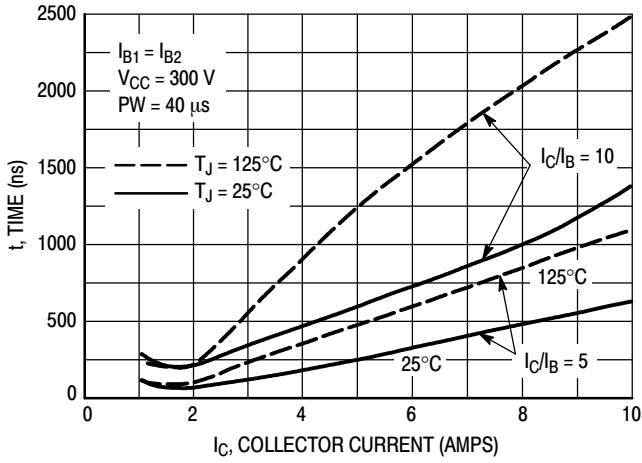

Figure 11. Resistive Switching Time, t_{on}

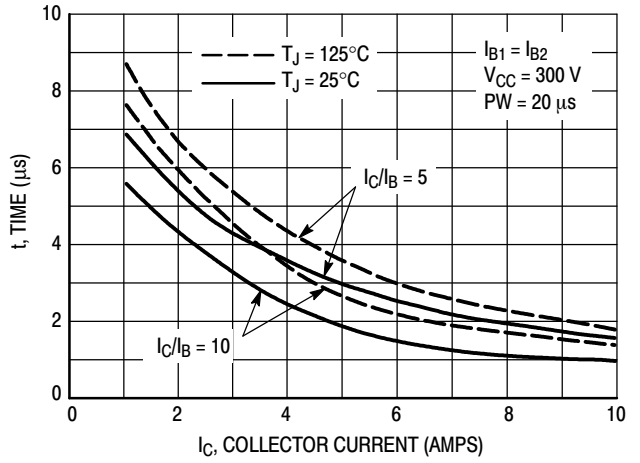

Figure 12. Resistive Switch Time, t_{off}

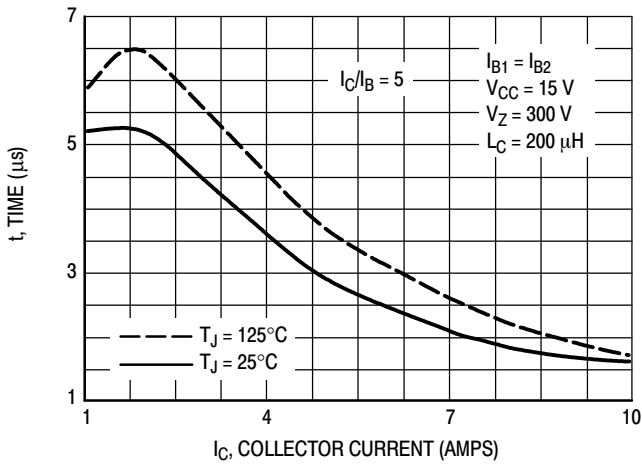

Figure 13. Inductive Storage Time, t_{si}

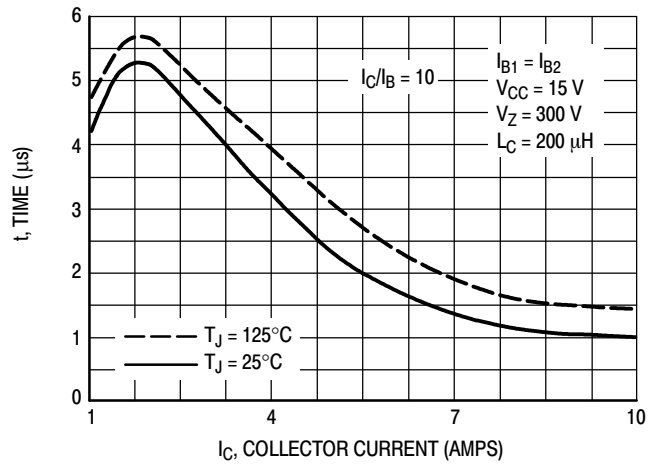

Figure 13 Bis. Inductive Storage Time, t_{si}

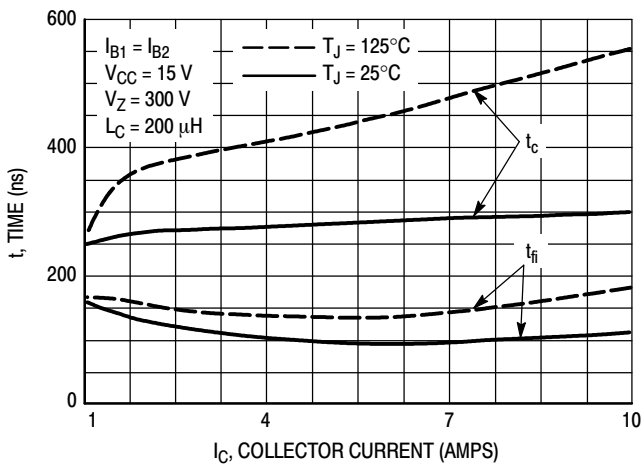

Figure 14. Inductive Storage Time, t_c & t_{fi} @ $I_C/I_B = 5$

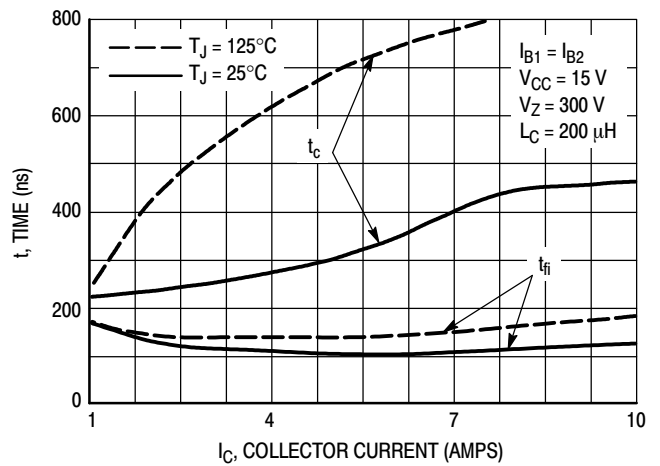

Figure 15. Inductive Storage Time, t_c & t_{fi} @ $I_C/I_B = 10$

TYPICAL SWITCHING CHARACTERISTICS

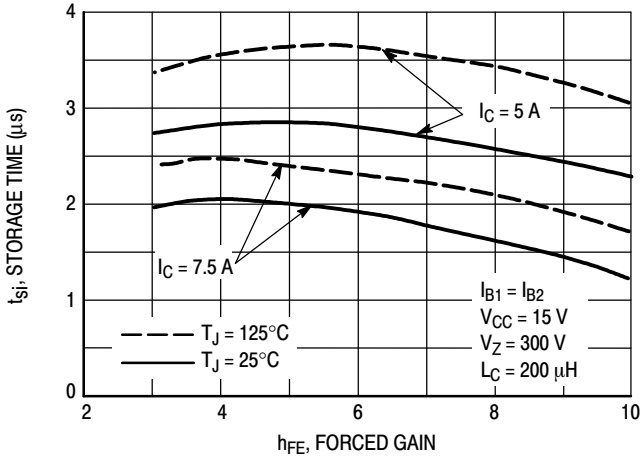

Figure 16. Inductive Storage Time

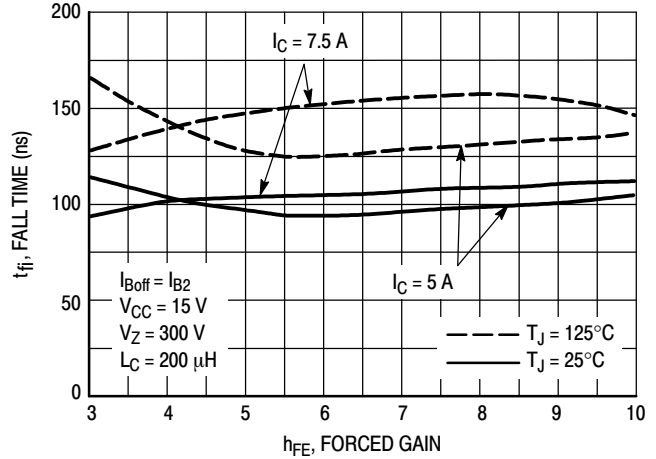

Figure 17. Inductive Fall Time

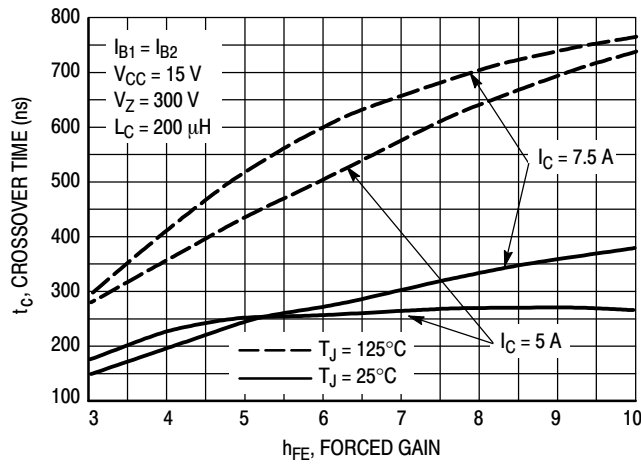

Figure 18. Inductive Crossover Time, t_c

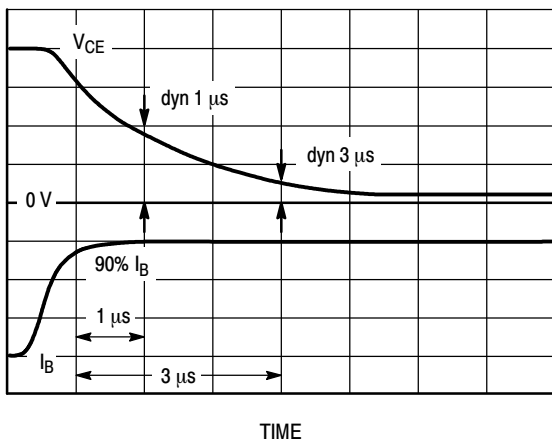

Figure 19. Dynamic Saturation Voltage Measurements

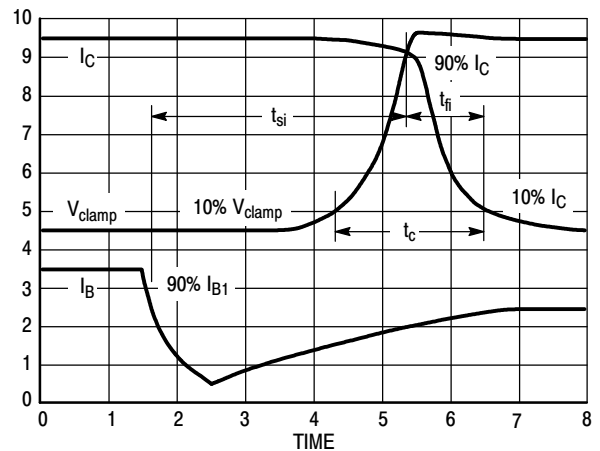
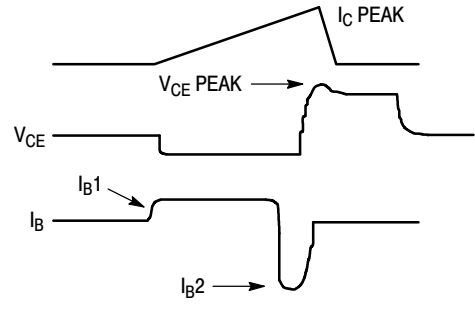
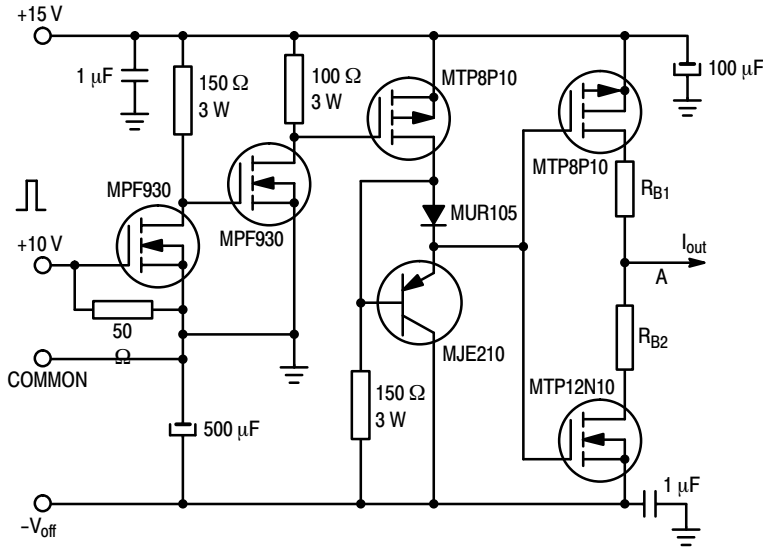

Figure 20. Inductive Switching Measurements

BUH100G

Table 1. Inductive Load Switching Drive Circuit



$V_{(BR)CEO(sus)}$	Inductive Switching	RBSOA
$L = 10 \text{ mH}$	$L = 200 \mu\text{H}$	$L = 500 \mu\text{H}$
$R_{B2} = \infty$	$R_{B2} = 0$	$R_{B2} = 0$
$V_{CC} = 20 \text{ V}$	$V_{CC} = 15 \text{ V}$	$V_{CC} = 15 \text{ V}$
$I_{C(pk)} = 100 \text{ mA}$	R_{B1} selected for desired I_{B1}	R_{B1} selected for desired I_{B1}

TYPICAL THERMAL RESPONSE

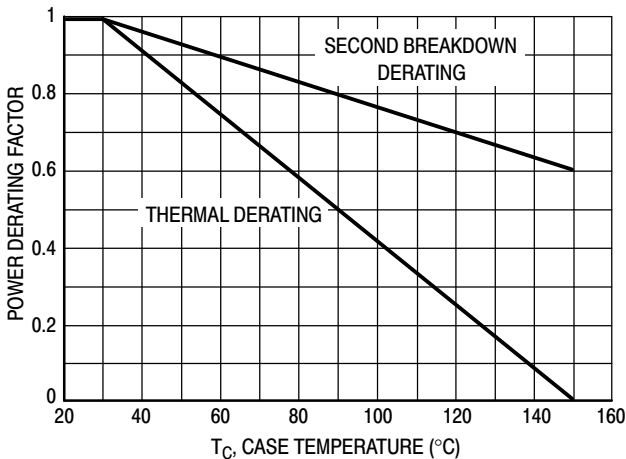

Figure 21. Forward Bias Power Derating

There are two limitations on the power handling ability of a transistor: average junction temperature and second breakdown. Safe operating area curves indicate I_C - V_{CE} limits of the transistor that must be observed for reliable operation; i.e., the transistor must not be subjected to greater dissipation than the curves indicate. The data of Figure 22 is based on $T_C = 25^\circ\text{C}$; $T_{J(pk)}$ is variable depending on power level. Second breakdown pulse limits are valid for duty cycles to 10% but must be derated when $T_C > 25^\circ\text{C}$. Second breakdown limitations do not derate the same as thermal limitations. Allowable current at the voltages shown on Figure 22 may be found at any case temperature by using the appropriate curve on Figure 21.

$T_{J(pk)}$ may be calculated from the data in Figure 24. At any case temperatures, thermal limitations will reduce the power that can be handled to values less than the limitations imposed by second breakdown. For inductive loads, high voltage and current must be sustained simultaneously during turn-off with the base to emitter junction reverse biased. The safe level is specified as a reverse biased safe operating area (Figure 23). This rating is verified under clamped conditions so that the device is never subjected to an avalanche mode.

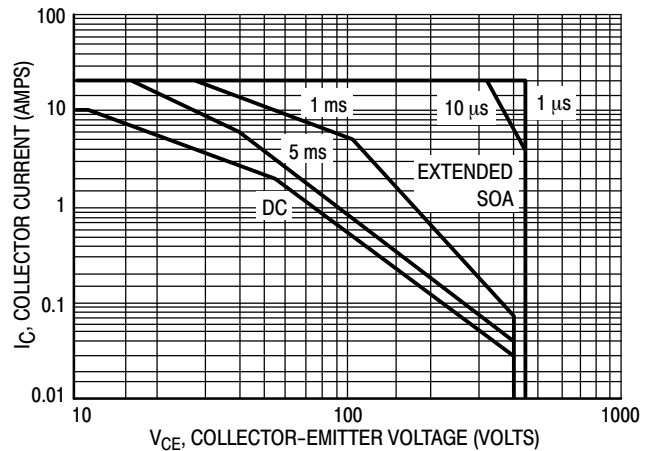

Figure 22. Forward Bias Safe Operating Area

BUH100G

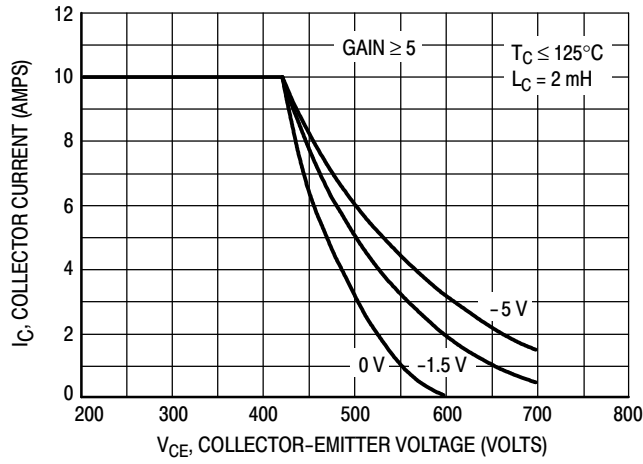

Figure 23. Reverse Bias Safe Operating Area

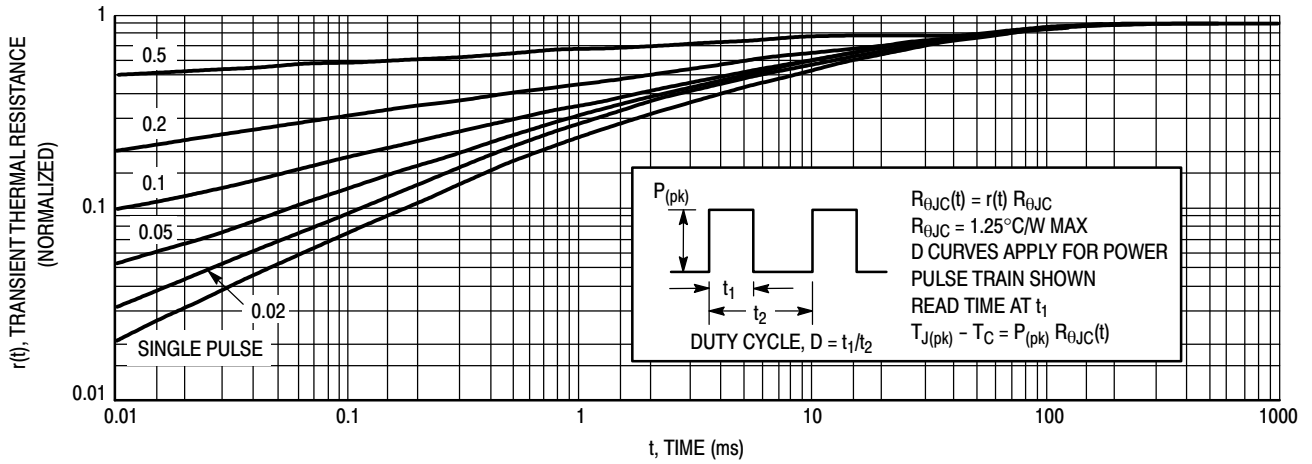
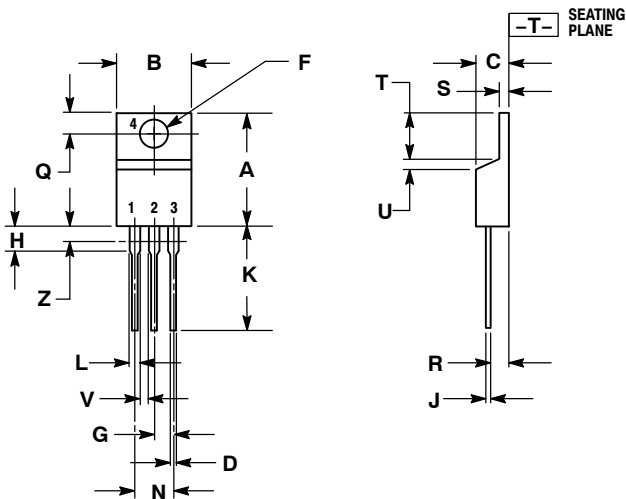

Figure 24. Typical Thermal Response ($Z_{\theta JC}(t)$) for BUH100

BUH100G

PACKAGE DIMENSIONS

TO-220AB
CASE 221A-09
ISSUE AF



NOTES:

1. DIMENSIONING AND TOLERANCING PER ANSI Y14.5M, 1982.
2. CONTROLLING DIMENSION: INCH.
3. DIMENSION Z DEFINES A ZONE WHERE ALL BODY AND LEAD IRREGULARITIES ARE ALLOWED.

DIM	INCHES		MILLIMETERS	
	MIN	MAX	MIN	MAX
A	0.570	0.620	14.48	15.75
B	0.380	0.405	9.66	10.28
C	0.160	0.190	4.07	4.82
D	0.025	0.035	0.64	0.88
F	0.142	0.161	3.61	4.09
G	0.095	0.105	2.42	2.66
H	0.110	0.155	2.80	3.93
J	0.014	0.025	0.36	0.64
K	0.500	0.562	12.70	14.27
L	0.045	0.060	1.15	1.52
N	0.190	0.210	4.83	5.33
Q	0.100	0.120	2.54	3.04
R	0.080	0.110	2.04	2.79
S	0.045	0.055	1.15	1.39
T	0.235	0.255	5.97	6.47
U	0.000	0.050	0.00	1.27
V	0.045	---	1.15	---
Z	---	0.080	---	2.04

STYLE 1:

1. BASE
2. COLLECTOR
3. EMITTER
4. COLLECTOR

SWITCHMODE is a trademark of Semiconductor Components Industries, LLC.

ON Semiconductor and are registered trademarks of Semiconductor Components Industries, LLC (SCILLC). SCILLC reserves the right to make changes without further notice to any products herein. SCILLC makes no warranty, representation or guarantee regarding the suitability of its products for any particular purpose, nor does SCILLC assume any liability arising out of the application or use of any product or circuit, and specifically disclaims any and all liability, including without limitation special, consequential or incidental damages. "Typical" parameters which may be provided in SCILLC data sheets and/or specifications can and do vary in different applications and actual performance may vary over time. All operating parameters, including "Typicals" must be validated for each customer application by customer's technical experts. SCILLC does not convey any license under its patent rights nor the rights of others. SCILLC products are not designed, intended, or authorized for use as components in systems intended for surgical implant into the body, or other applications intended to support or sustain life, or for any other application in which the failure of the SCILLC product could create a situation where personal injury or death may occur. Should Buyer purchase or use SCILLC products for any such unintended or unauthorized application, Buyer shall indemnify and hold SCILLC and its officers, employees, subsidiaries, affiliates, and distributors harmless against all claims, costs, damages, and expenses, and reasonable attorney fees arising out of, directly or indirectly, any claim of personal injury or death associated with such unintended or unauthorized use, even if such claim alleges that SCILLC was negligent regarding the design or manufacture of the part. SCILLC is an Equal Opportunity/Affirmative Action Employer. This literature is subject to all applicable copyright laws and is not for resale in any manner.

PUBLICATION ORDERING INFORMATION

LITERATURE FULFILLMENT:

Literature Distribution Center for ON Semiconductor
P.O. Box 5163, Denver, Colorado 80217 USA
Phone: 303-675-2175 or 800-344-3860 Toll Free USA/Canada
Fax: 303-675-2176 or 800-344-3867 Toll Free USA/Canada
Email: orderlit@onsemi.com

N. American Technical Support: 800-282-9855 Toll Free USA/Canada
Europe, Middle East and Africa Technical Support:
Phone: 421 33 790 2910
Japan Customer Focus Center
Phone: 81-3-5773-3850

ON Semiconductor Website: www.onsemi.com

Order Literature: <http://www.onsemi.com/orderlit>

For additional information, please contact your local Sales Representative